

## Double-acting Cylinder

### Overview

This series is to ISO 15552, and its diameter ranges from 32 to 125, having various variants.

### Feature

- Square aluminium tube, without rods, good corrosion resistance.
- A variety of cushioning options with smooth adjustment.
- Piston seal adopts two Y-type unidirectional sealing structure, with compensation function, low operating pressure and high service life.
- Diversified bracket: a variety of fixed and non-foxed bracket for customers to choose from.



### Graphical Symbol

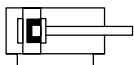

P: Elastic cushioning

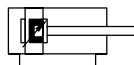

PPV: Pneumatic adjustable cushioning

### How to order

DPSP	-32	× 50	-PPV	-A	-2FE1T			
Double acting	①	②	③	④	⑤			
①	- Diameter : 32,40,50,63,80,100,125							
②	× Stroke length :1...2800							
③	- Cushioning: P=Elastic cushioning rings/ plates at both ends; PPV= Pneumatic adjustable cushioning at both ends.							
④	- Position sensing: A= for proximity sensor.							
⑤	- Variant							
	Piston rod type		Piston rod thread type		End-position locking	Temperature range		
	At one end	-	Maie thread	-	Both sides	E1	Standard	-
	Through piston rod	2	Female thread	F	With advanced piston rod	E2	-40~80°C	T
-	-	-	-	With retracted piston rod	E3	Heat-resistant seals Max120°C	R	

## Data sheet

General technical data							
Piston diameter $\phi$	32	40	50	63	80	100	125
Standard	ISO 15552						
Operating mode	Double acting						
Pneumatic connection	G1/8	G1/4	G1/4	G3/8	G3/8	G1/2	G1/2
Piston rod thread	M10x1.25	M12x1.25	M16x1.5	M16x1.5	M20x1.5	M20x1.5	M27x2
Stroke length [mm]	1 ... 2800						
Design	Piston/ piston rod/ cylinder barrel						
Cushioning							
DPSP-...-P	Elastic cushioning rings/plates at both ends						
DPSP-...-PPV	Pneumatic cushioning, adjustable at both ends						
Cushioning length							
-PPV [mm]	17	19	22	22	31	31	45
Position sensing	Via proximity switch						
Type of mounting	With female thread /With accessories						
Mounting position	Any						
Operating and environmental conditions							
Operating medium	Compressed air (filtered through 40 $\mu$ m or more)						
Operating pressure [MPa]	0.06 ... 1.2		0.04 ... 1.2			0.02 ... 1	
Ambient and fluid temperature	-20 ~ 80° C						
Corrosion resistance class	2						
Force [N] and impact energy [J]							
Theoretical force at 6 bar advancing	483	754	1178	1870	3016	4712	7363
Theoretical force at 6 bar retracting	415	633	990	1682	2721	4418	6881
Max.impact energy in the end positions	0.4	0.7	1.0	1.3	1.8	2.5	3.3

## Dimensions

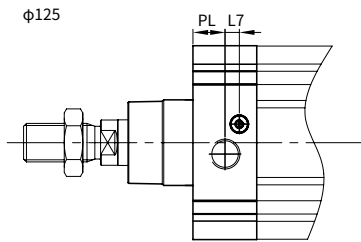
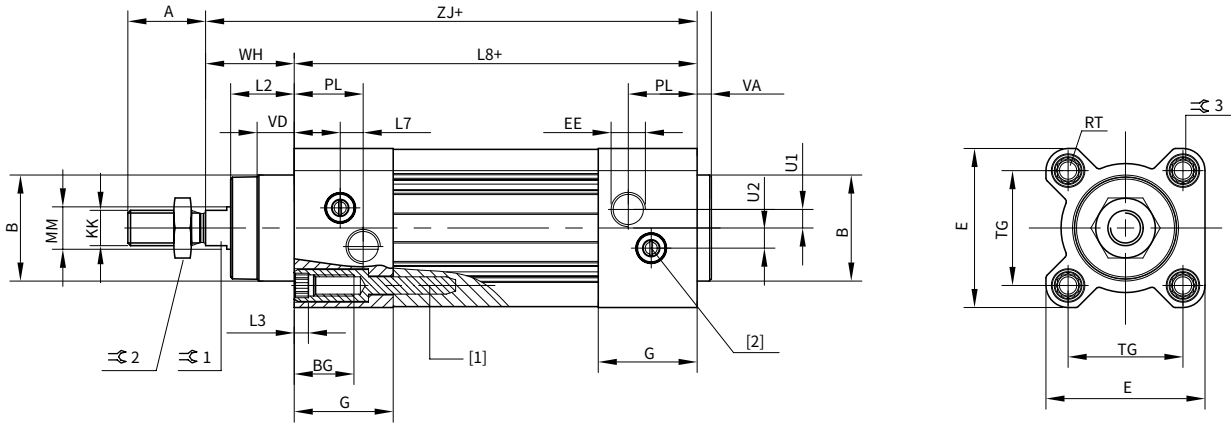

+ = plus stroke length

[1] Socket head screw with female thread for mounting components

[2] Adjusting screw for adjustable end-position cushioning

2- Through piston rod

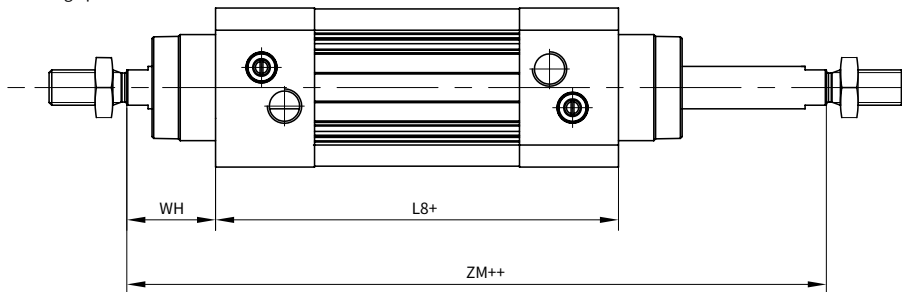

+ = plus stroke length

++ = plus 2x stroke length

## Dimensions

Diameter $\phi$ [mm]	A-0.5	B $\phi$ d11	BGmin	E+0.5	EE	G-0.2	U2 $\pm$ 0.1	U1 $\pm$ 0.1	KK
32	22	30	16	45	G1/8	28	5.7	5.25	M10x1.25
40	24	35	16	54	G1/4	33	8	4	M12x1.25
50	32	40	16	64	G1/4	33	10.4	5.5	M16x1.5
63	32	45	16	75	G3/8	40.3	12.75	6.25	M16x1.5
80	40	45	17	93	G3/8	43	12.5	8	M20x1.5
100	40	55	17	110	G1/2	48	13.5	10	M20x1.5
125	54	60	20	136	G1/2	44.7	13	8	M27x2

Diameter $\phi$ [mm]	L2	L3max.	L7	L8 $\pm$ 0.4	MM $\phi$	PL $\pm$ 0.1	RT	TG $\pm$ 0.3
32	18-0.2	5	6.5	94	12	19.5	M6	32.5
40	21.3-0.2	5	7.5	105	16	22.5	M6	38
50	26.8-0.2	5	9.5	106	20	22.5	M8	46.5
63	27-0.2	5	9	121	20	27.5	M8	56.5
80	34.2-0.2	-	11	128	25	30	M10	72
100	38-0.2	-	7.5	138	25	31.5	M10	89
125	45.5-0.3	-	10	160	32	22.5	M12	110

Diameter $\phi$ [mm]	VA	VD+0.5	WH+2.2	ZJ+1.8	ZM	$\varnothing$ 1	$\varnothing$ 2	$\varnothing$ 3
32	4 <sub>-0.2</sub>	10	25	119.1	146.1	10	16	6
40	4 <sub>-0.2</sub>	10.5	28.7	133.9	164.8	13	18	6
50	4 <sub>-0.2</sub>	11.5	35.6	141.8	179.8	17	24	8
63	4 <sub>-0.2</sub>	15	35.9	157.1	195.4	17	24	8
80	4 <sub>-0.2</sub>	15.7	45.4	173.6	221	22	30	6
100	4 <sub>-0.2</sub>	19.2	49.3	187.5	238.8	22	30	6
125	6 <sub>-0.3</sub>	20.5	64.1	225	290	27	41	8

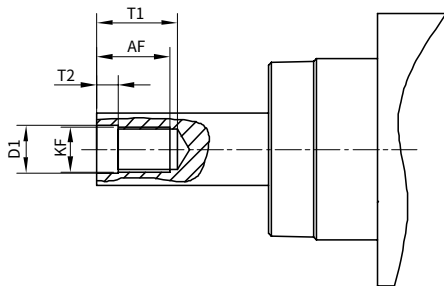

F - Female thread					
$\phi$ [mm]	AFmin.	D1	KF	T1max.	T2
32	12	6.4	M6	16	2.6
40	12	8.4	M8	16	3.3
50	16	10.5	M10	21	4.7
63	16	10.5	M10	21	4.7
80	20	13	M12	26.5	6.1
100	20	13	M12	26.5	6.1
125	32	17	M16	40	8

## Type of mounting

### LB Foot mounting

Material: Galvanised steel

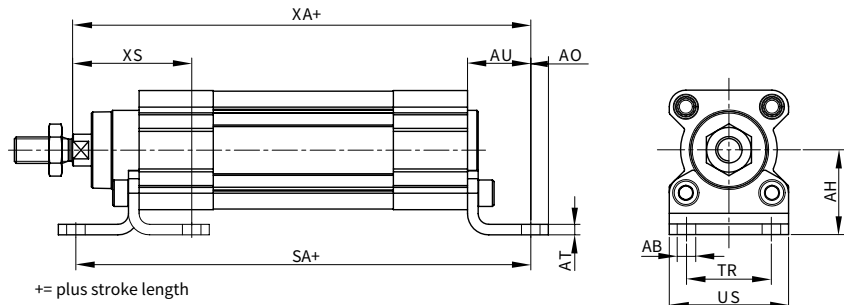

Diameter $\phi$ [mm]	AB $\phi$	AH	AO	AT	AU	SA	TR	US	XA	XS	Type
32	7	32	8	3	24	142	32	47	143.1	46	LB-32
40	9	36	9	3	28	161	36	53	161.9	53.7	LB-40
50	9	45	10	3	32	170	45	65	173.8	64.6	LB-50
63	9	50	12	3	32	185	50	75	189.1	64.9	LB-63
80	12.5	63	19	4	41	210	63	95	214.6	82.4	LB-80
100	14.5	71	19	4	41	220	75	115	228.5	86.3	LB-100
125	16.5	90	20	8	45	250	90	140	270	101.1	LB-125

### FA/FB Flange mounting

Material: Galvanised steel

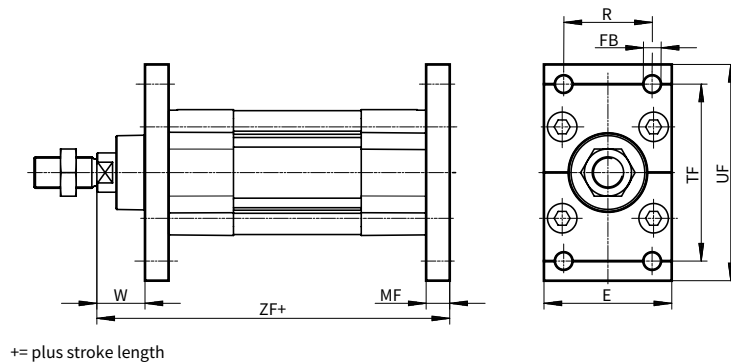

Diameter $\phi$ [mm]	E	FB $\phi$ H13	MF	R	TF	UF	W	ZF	Type
32	47	7	10	32	64	80	16	129.1	FA/FB-32
40	53	9	10	36	72	90	18.7	143.9	FA/FB-40
50	65	9	12	45	90	108	23.6	153.8	FA/FB-50
63	75	9	12	50	100	118	23.9	169.1	FA/FB-63
80	95	12.5	16	63	126	150	29.4	189.6	FA/FB-80
100	115	14.5	16	75	150	176	33.3	203.5	FA/FB-100
125	139	16.5	20	90	180	218	45	245	FA/FB-125

## Type of mounting

### TA/TB Trunnion flange

Material: Ductile stainless steel

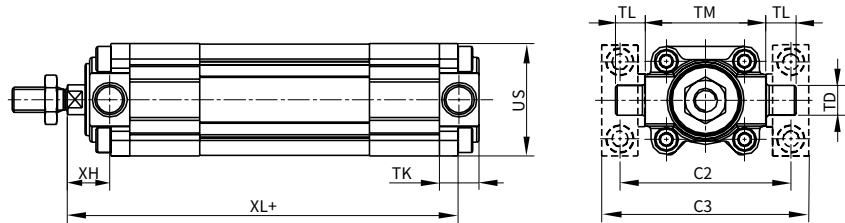

+ = plus stroke length

Diameter $\phi$ [mm]	C2	C3	TD $\phi$ e9	TK	TL	TM	US	XH	XL	Type
32	71	86	12	19	12	50	45	17	128	TA/TB-32
40	87	105	16	21	16	63	54	18.7	144.7	TA/TB-40
50	99	117	16	26	16	75	64	23.6	155.6	TA/TB-50
63	116	136	20	28	20	90	75	23.9	172.9	TA/TB-63
80	136	156	20	31	20	110	93	31.4	190.4	TA/TB-80
100	164	189	25	35	25	132	110	30.3	203.3	TA/TB-100
125	192	217	25	43	25	160	131	39.1	242.1	TA/TB-125

### CAQ Swivel flange

Material: diameter 32 ... 50: Die-cast aluminum  
diameter 63 ... 125: Wrought aluminum allo

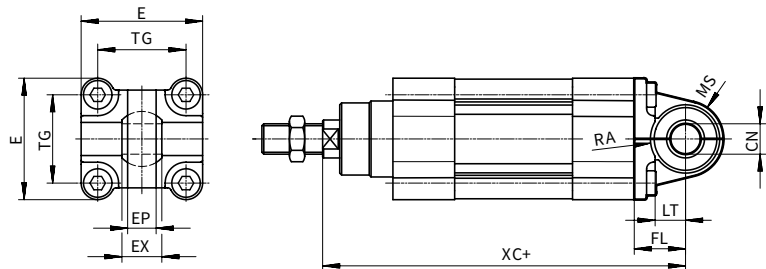

+ = plus stroke length

Diameter $\phi$ [mm]	CN $\phi$	E	EP $\pm$ 0.2	EX	FL $\pm$ 0.2	LT	MS	RA+1	TG	XC	Type
32	10+0.013	45+0.2/-0.5	10.5	14	22	13	15+0.5	14.5	32.5	141.1	CAQ-32
40	12+0.015	54-0.5	12	16	25	16	17+0.5	17.5	38	158.9	CAQ-40
50	16+0.015	64-0.6	15	21	27	16	20+0.5	18.5	46.5	168.8	CAQ-50
63	16+0.015	74.5 $\pm$ 0.5	15	21	32	21	23-0.5	23	56.5	189.1	CAQ-63
80	20+0.018	92.2 $\pm$ 0.8	18	25	36	22	28-0.5	36	72	209.6	CAQ-80
100	20+0.018	109+1/-0.7	18	25	41	27	30 $\pm$ 0.5	95	89	228.5	CAQ-100
125	30+0.018	132+1/-0.7	25	37	50	30	39 $\pm$ 0.5	100	110	275	CAQ-125

## Type of mounting

### CB Swivel flange

Material: Die-cast aluminum

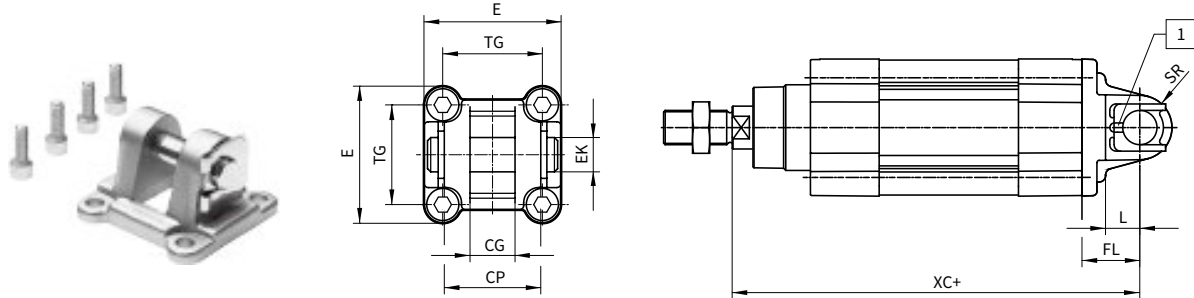

Diameter $\phi$ [mm]	CG H14	CP H14	E	EK $\phi$ H9	FL $\pm 0.2$	L	SR	TG	XC	Type
32	14	34 <sup>+0.2</sup> <sub>-0.5</sub>	45	10	22	13	10	32.5	141.1	CB-32
40	16	40 <sup>-0.5</sup>	54	12	25	16	12	38	158.9	CB-40
50	21	45 <sup>-0.6</sup>	64	16	27	16	12	46.5	168.8	CB-50
63	21	51 <sup>-0.6</sup>	75	16	32	21	16	56.5	189.1	CB-63
80	25	65 <sup>-0.8</sup>	93	20	36	22	16	72	209.6	CB-80
100	25	75 <sup>+0.3</sup> <sub>-0.8</sub>	110	20	41	27	20	89	228.5	CB-100
125	37	97 <sup>-0.8</sup>	131	30	50	30	25	110	275	CB-125

### CA Swivel flange

Material: Die-cast aluminum

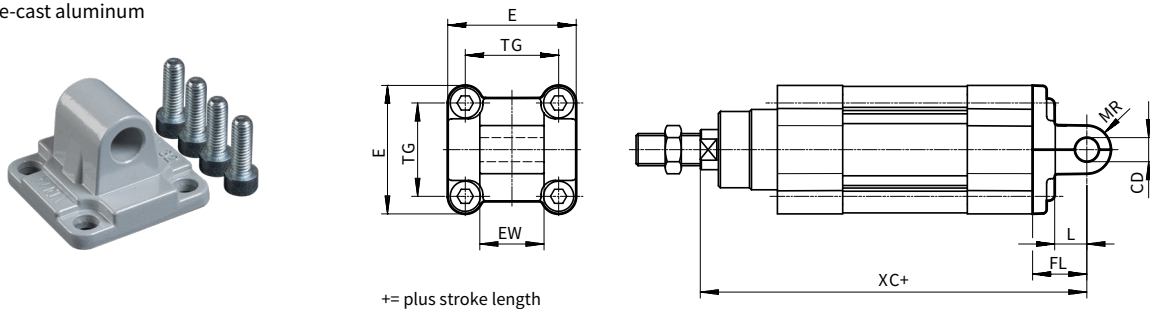

Diameter $\phi$ [mm]	CD $\phi$ H9	E	EWh12	FL $\pm 0.2$	L	MR	TG	XC	Type
32	10	45 <sup>+0.2/-0.5</sup>	26	22	13	10	32.5	141.1	CA-32
40	12	54 <sup>-0.5</sup>	28	25	16	12	38	158.9	CA-40
50	12	64 <sup>-0.6</sup>	32	27	16	12	46.5	168.8	CA-50
63	16	75 <sup>-0.6</sup>	40	32	21	16	56.5	189.1	CA-63
80	16	93 <sup>-0.8</sup>	50	36	22	16	72	209.6	CA-80
100	20	110 <sup>+0.3/-0.8</sup>	60	41	27	20	89	228.5	CA-100
125	25	131 <sup>-0.8</sup>	70	50	30	25	110	275	CA-125

## Type of mounting

### CB-C Swivel flange

Material: Die-cast aluminium

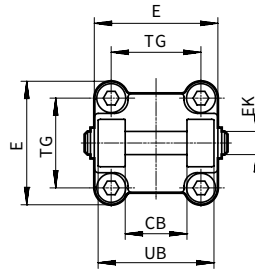

+ = plus stroke length

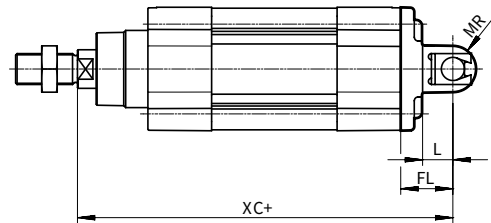

Diameter $\phi$ [mm]	CBh14	E	EK $\phi$ H9/e8	FL $\pm$ 0.2	L	MR-0.5	TG	UBh14	XC	Type
32	26	45+0.2/-0.5	10	22	13	8.5	32.5	45	141.1	CB-32-C
40	28	54-0.5	12	25	16	12	38	52	158.9	CB-40-C
50	32	64-0.6	12	27	16	12	46.5	60	168.8	CB-50-C
63	40	75-0.6	16	32	21	16	56.5	70	189.1	CB-63-C
80	50	93-0.8	16	36	22	16	72	90	209.6	CB-80-C
100	60	110+0.3/-0.8	20	41	27	20	89	110	228.5	CB-100-C
125	70	131-0.8	25	50	30	25	110	130	275	CB-125-C

### DW Multi-position kit

Material:  
Flange: Wrought aluminum alloy  
Threaded pin, Hex nut: Galvanised steel

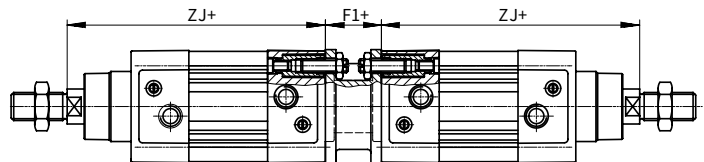
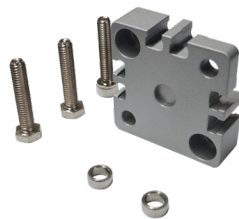

Diameter $\phi$ [mm]	F1	ZJ +1.8	Max total stroke length [mm]	Achieve three positions connect two cylinders with the same stroke length	Achieve four positions connect two cylinders with different stroke lengths	Type
32	27	119.1	500			DW-32
40	27	133.9	800			DW-40
50	32	141.8	800			DW-50
63	28	157.1	700			DW-63
80	38	173.6	1000			DW-80
100	38	187.5	900			DW-100
125	48	225	1000			DW-125



## Type of mounting

### TC Trunnion flange kit

The kit can be attached at any position along the profile barrel of the cylinder

Material: Die-cast aluminum

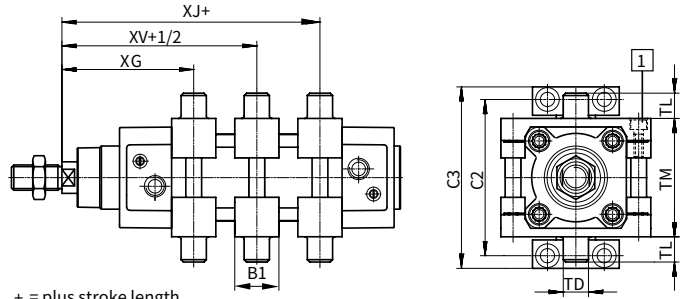
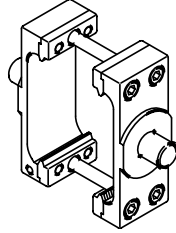

+ = plus stroke length

+1/2 = plus half stroke length

[1] Max. tightening torque

Diameter $\phi$ [mm]	B1	C2	C3	TD $\phi$ 9	TL	TM	UW	XGmin.	XJmax.	XV	Max.[Nm]	Type
32	30	71	86	12	12	50	65	69 $\pm$ 1.4	76 $\pm$ 1.4	73 $\pm$ 1.4	4+1	TC-32
40	32	87	105	16	16	63	75	77.7 $\pm$ 1.4	84.9 $\pm$ 1.4	81.2 $\pm$ 1.4	8+1	TC-40
50	34	99	117	16	16	75	95	85.6 $\pm$ 1.4	91.8 $\pm$ 1.4	88.6 $\pm$ 1.4	8+2	TC-50
63	41	116	136	20	20	90	105	96.9 $\pm$ 1.8	96.1 $\pm$ 1.8	96.4 $\pm$ 1.8	18+2	TC-63
80	41	136	156	20	20	110	130	110.4 $\pm$ 1.8	108.6 $\pm$ 1.8	109.4 $\pm$ 1.8	28+2	TC-80
100	48	164	189	25	25	132	145	121.3 $\pm$ 1.8	115.5 $\pm$ 1.8	118.3 $\pm$ 1.8	28+2	TC-100
125	50	192	217	25	25	160	177	134.7 $\pm$ 1.8	155.3 $\pm$ 1.8	145 $\pm$ 1.8	40+2	TC-125

## Peripherals overview

· DPSP...

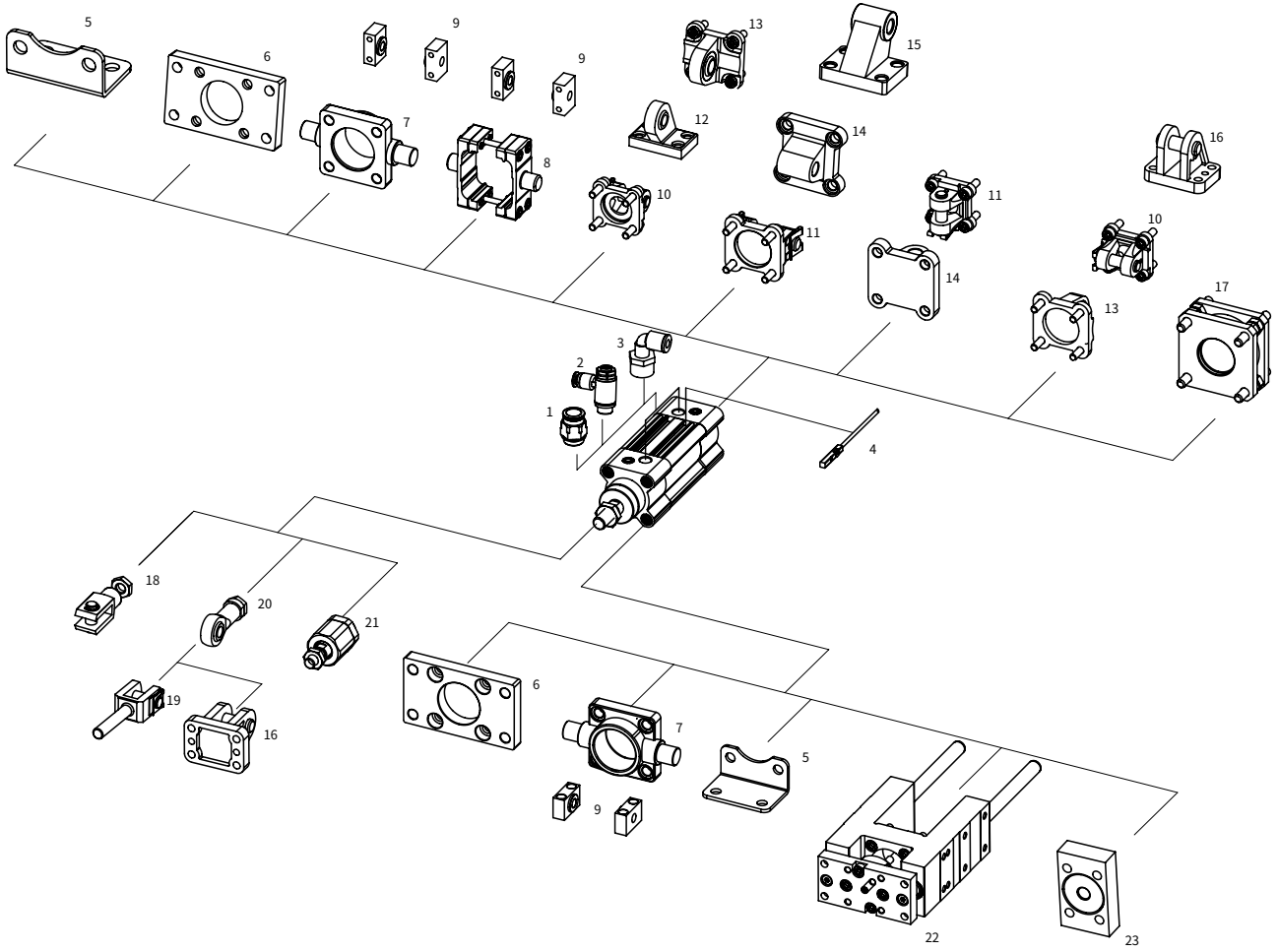

Actuator element

Control element

Service unit combination

Attachment

## Peripherals overview

### · List of Installed Originals and Accessories

Number	Hengli Code	Name	Brief description
1	PC	Push-in fitting	Straight for connecting compressed air tubing with standard O.D, refer to P461 for model details
2	NSE	One-way flow control valve	For speed regulation, refer to P500 for model details
3	PL	Push-in fitting	Right angle, for connecting tubing with standard O.D.
4	CDX	Proximity switch	Can be integrated into the cylinder profile
5	LB	Foot mounting	For bearing or end caps
6	FA/FB	Flange mounting	For bearing or end caps
7	TA/TB	Trunnion flange	For bearing or end caps
8	TC	Trunnion flange kit	For mounting anywhere along the cylinder profile barrel
9	TZ	Trunnion support	For trunnion flange TA/TB
10	CB	Swivel flange	For end caps
11	CB-C	Swivel flange	For end caps
12	LNQ	Clevis foot	With spherical bearing
13	CAQ	Swivel flange	For end caps
14	CA	Swivel flange	For end caps
15	LN	Clevis foot	For CB
16	CBG	Clevis foot	-
17	DW	Multi-position kit	For connecting two cylinders with the same piston diameter to form a multi-position cylinder
18	Y	Y Rod clevis	Permits a swivelling movement of the cylinder in one plane
19	YF	Y Rod clevis	With male thread
20	YY	Rod eye	With spherical bearing
21	FD	Self-aligning rod coupler	To compensate for radial and angular deviations
22	HFEG	Guide unit	For protecting standards-based cylinders against rotation at high torques
23	HKSG	Coupling piece	To compensate for radial deviations
	HKSZ	Coupling piece	For cylinders with a non-rotating piston rod to compensate for radial deviations

## Peripherals overview

### · Piston rod accessories

Name	Available $\phi$	Model	Name	Available $\phi$	Model	Name	Available $\phi$	Model
Rod eye YY			Y Rod clevis			Self-aligning rod coupler		
	32	YY-M10×1.25		32	Y-M10×1.25		32	FD-M10×1.25
	40	YY-M12×1.25		40	Y-M12×1.25		40	FD-M12×1.25
	50	YY-M16×1.5		50	Y-M16×1.5		50	FD-M16×1.5
	63			63			63	
	80	YY-M20×1.5		80	Y-M20×1.5		80	FD-M20×1.5
	100			100			100	
	125	Y-M27×2		125	Y-M27×2		125	FD-M27×2

Refer to P252 for more details

### · Proximity switch model selection chart

CDX	-13	-P	-O	-2.5	-M8	-G3	-220V	-L
Proximity switch	①	②	③	④	⑤	⑥	⑦	⑧
①	Slot form: 13= T slot							
②	Switch output: P=PNP, NPN=N, R=reed							
③	O/C: O=N/O contact, C=N/C contact							
④	Cable length(meter):: 0.3, 2.5, 5 (0.3 only for plug)							
⑤	Electrical connection: open end(default not specified) M8, M12 (plug)							
⑥	Number of plug pins: G3=3 pins (default not specified), G5=5 pins							
⑦	Rated operating voltage: 24V (default not specified), 220V							
⑧	LED: L(default not specified), W=without LED							

### · Proximity switch

Cylinder model	Name	Electrical connection	Switching output	Hengli Type	Applicable piston diameter
DPSP	proximity switch	Open end	Magneto-resistive, 3-wire PNP	CDX-13P-O-2.5	32,40,50,63,80,100,125
				CDX-13P-O-5	
			Magneto-resistive, 3-wire NPN	CDX-13N-O-2.5	
				CDX-13N-O-5	
			Magnetic reed, 2-wire R	CDX-13R-O-2.5	
				CDX-13R-O-5	
		Plug	Magneto-resistive, 3-wire PNP	CDX-13P-O-0.3-M8	
				CDX-13P-O-0.3-M12	
			Magneto-resistive, 3-wire NPN	CDX-13N-O-0.3-M8	
				CDX-13N-O-0.3-M12	
			Magnetic reed, 2-wire R	CDX-13R-O-0.3-M8	
				CDX-13R-O-0.3-M12	